

1 - Upper Assembly & Components

- 854 Connector Screw Set (38)
HFG537 Fastener - 10-32 x 1/4" 18-8 Slit Ov
- 855 Wedge Set (22)
HFG216 Connector Wedge
- 971 Locking Collar - w/Insert
971Collar Collar
HFG315 Plastic Insert
- 869 Trim Cap
- 897 Extrusion - 7' Luff
- 898 Extrusion - 2' Luff
- 899 Connector - 9"
- 911 Connector - 11.355" Bottom
- 912 Halyard Swivel
4456 Label - 3/8" x 2 1/8"
HCP1505 Shackle - 8 mm Bow
HCP1506 Shackle - 8 mm Twist
HCP723 Snap Ring - Large (order 2)
HCP722 Snap Ring - Small
HBB7 Ball Bearing - 3/8" Torlon (order 92)
- 984 Torque Tube
4753 Label - Small Red Oval
HFG730 Set Torque Tube Clamp Screws (2)
HFS335 Fastener - M8 x 1.25 x 35 316 Sk Cap
- 939 Feeder
HFS192 Fastener - 10-32 x 3/8" 18-8 Slit Ov (order 2)
- HFG137 Extrusion Set (8 Long, 1 Short)
897 Extrusion - 7' Luff
898 Extrusion - 2' Luff
- HFG635 Fastener Set - Torque Tube (3)
HFS336 Fastener - M8 x 1.25 x 16 A4 Sk Cap

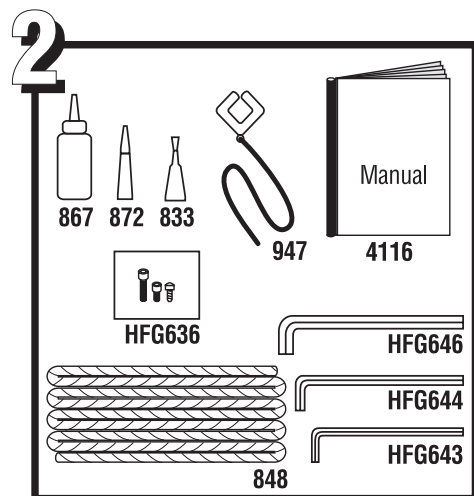

2 - Accessories

- 4116 Manual - Furling
- 833 Loctite - Blue
- 848 Line - 3/8" x 100'
- 867 Loctite - 2 Red
- 872 Super Glue
- 947 Prefeeder - Phenolic w/Line
- HFG636 Fastener Set - Spare
- HFG643 Wrench - M5 Allen Short
- HFG644 Wrench - M6 Allen Short
- HFG646 Wrench - M8 Allen Long

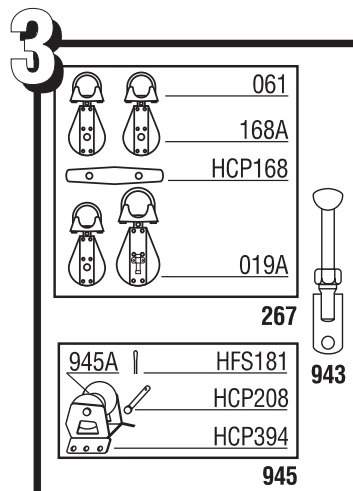

3 - Optional Parts

- 267 Kit - Medium Lead Block
019A Block - 2.25" Hex Stbd
061 Stanchion Mount Base
168A Block - Bullet Swivel
HCP168 Cleat - 4" Black
- 943 Isomat Adapter
- 945 Halyard Restrainer - Small
945A Sheave & SS Inner Race Only
HCP208 Clevis Pin - 5/16" x 1.250" 18-8
HCP394 Bracket - Halyard Restrainer - Large
HFS181 Cotter Pin - 3/32" x .750" 18-8

4

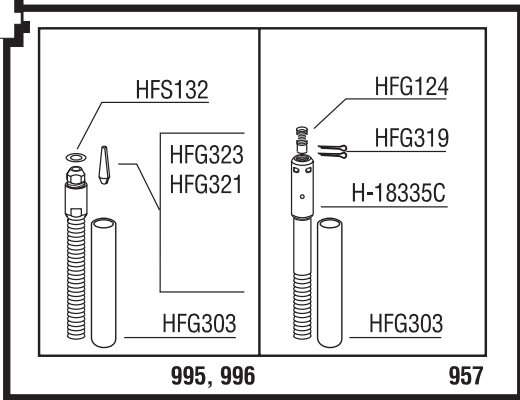

4 - Studs & Components

Sta-Lok Studs

- HFG303 Stud-Cap - 7/8" ID x 5.5" Red
- 995 Stud - 7/16" (11 mm) Sta-Lok
- HFG323 Wedge - 7/16" (11 mm) Sta-Lok
- HFS132 Washer - 1/2" .062 x .531 x 1.250 18-8
- 996 Stud - 12 mm Sta-Lok
- HFG321 Wedge - 12 mm Sta-Lok
- HFS132 Washer - 1/2" .062 x .531 x 1.250 18-8

Rod

- HFG303 Stud-Cap - 7/8" ID x 5.5" Red
- 957 Stud -22 Rod Adpt w/Nosepiece
- H-18335G Stud - Main Body
- HFG124 Nosepiece -12
- HFG319 Cotter Pin - 3/32" x 1.750" 18-8

5

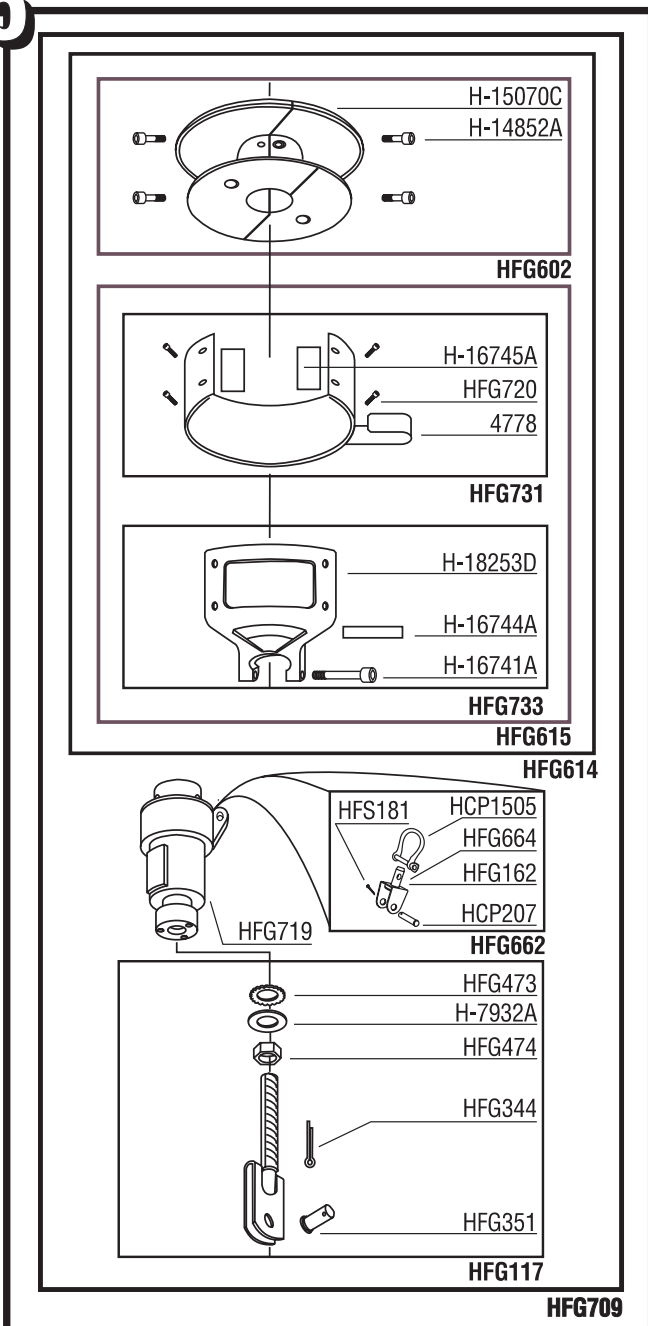

5 - Drum Assembly & Components

HFG709

- HFG614 Hub Complete
- HFG614 Cowling - w/Guard & Spool
- HFG602 Spool Assembly - Complete
- H-14852A Fastener - M6 x 1.00-6G 316 (order 4)
- H-15070C Spool Assembly Half
- HFG615 Cowling - w/Guard
- HFG731 Cowling - w/Shims & Fst
- 4778 Label - Cowling
- HFG720 Fastener Set - Guard
- H-16745A Mylar Cowling Shim (order 2)
- HFG733 Guard - w/Shims & Fastener
- H-18253D Line Guard
- H-16741A Fastener - M10 x 1.50 GC Screw
- H-16744A Mylar Guard Clamp Shim
- HFG117 Lower Toggle
- HFG351 Clevis Pin - Lower Toggle
- HFG344 Cotter Pin
- HFG474 Lock Nut
- HFG473 Lockwasher - Toggle
- H-7932A Flat Washer - Lower Toggle
- HFG719 Hub - w/o Lower Toggle
- HFG662 Tack Shackle Assembly
- HCP1505 Shackle - 8 mm Bow
- HFG664 Swivel Bracket w/swivel pin
- HCP207 Clevis Pin - 5/16"
- HFG162 Plastic Washer
- HFS181 Cotter Pin - 3/32" x .750 18-8